

VIVID S 160 DYNAMIC WHITE

Table of Contents

Specifications	2-4	Mounting Hardware	8-9
Technical Specifications	2	Standard	8
Physical Specifications	3	Plastic	8
		Spring Clip	9
Part Number Naming	3	Flexible	9
Connectors	4-7	Packaging	10
Seamless	4	Testing	10-15
Submersible Seamless	5	Photometric Data	10
Snap	6	Certifications	11
Barrel	7	Fixture Testing	11
		Charts	12-15

Technical Specifications

Light Dimension 0.45 x 0.83in (11.5x21mm)

Output		W/WW
LED Light	Epistar or Nichia SMD LED Chip	
Max Run Length*		
Single Feed	32.81ft (10m)	
Double Feed	65.62ft (20m)	
Light Surface	Square profile 160°	
Lumen Maintenance	70,000 Hours L70 @ 25°C : 90,000 L50 @ 25°C 50,000 Hours L70 @ 50°C : 70,000 Hours L50 @ 50°C	
Electrical		
Input Voltage	24V DC	
Power Consumption	3.66W/ft (12W/m)	
Physical		
LED Count	44 LEDs / ft (144 LEDs/m)	
LED Spacing	0.55in (13.89mm)	
Cutting Unit Length	3.28in (83.3mm) (12 LEDs)	
Thermal Management	Free air convection	
Fixture Connections	End, side & bottom lead wires	
Minimum Bend Diameter	4.72in (120mm) (Side Bending)	
Temperature Ranges		
Installation	32°F to 140°F (0°C to 60°C)	
Operating	-13°F to 140°F (-25°C to 60°C)	
Humidity	0-95% non condensing	
Dependability		
Warranty	5 Year Warranty	
Safety		
Certification	Tested to UL & CSA by Underwriters Laboratory for use in USA and Canada, complies with California Title 24 Requirements, Lighting Facts. Exceeds ANSI C78.377A, CE & RoHS Compliant.	
IP Rating	IP68 with appropriately rated accessories	

*Max Run Length: Unless otherwise stated, snap and seamless run lengths are the same.

Available Colors

Color	CCT Wavelength
WW	2460 ± 120K
W	5029 ± 283K
W+WW	3465 ± 245K

Lumen Count

Color	Per Foot	Per Meter	Power
WW	>33.53lm	>110lm	N/A
W	>33.53lm	>110lm	N/A
W+WW	>67.06lm	>220lm	3.66W/ft (12W/m)

*Color Jackets:

For standard or custom color jacket options, contact your Account Manager. Min. order quantity of 656ft (200m).

Physical Specifications



Light Profile

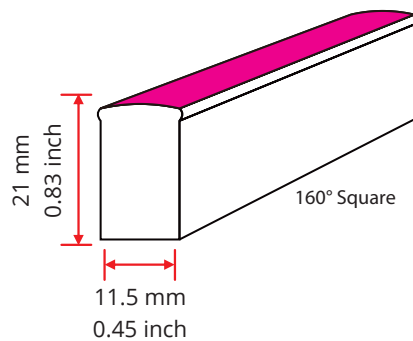

Bending Direction

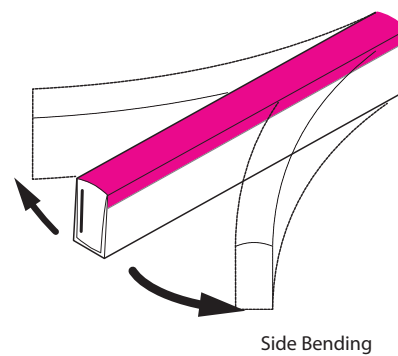

Minimum Bending Diameter

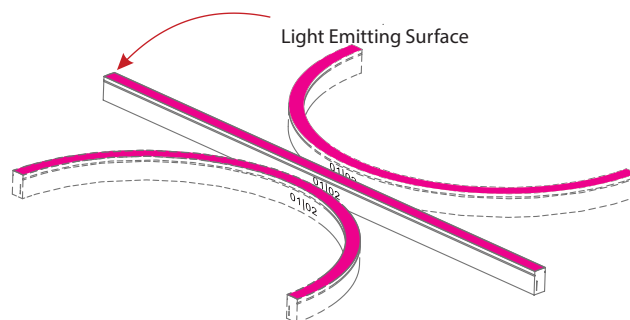
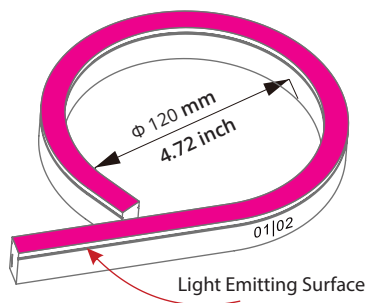

Part Number Naming Convention

NF-11B-1-01-3W-X-XXX-24DC

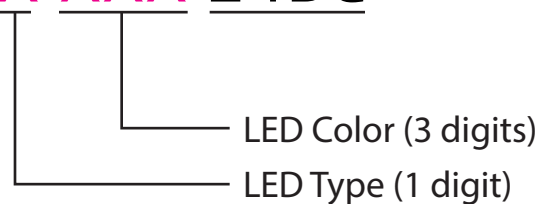

For full part number naming rules, please refer to the document on www.glls.com/support/documentation/

Connectors

Seamless Connectors

IP67: Rated for wet locations, not submersion.
Factory Assembly only.

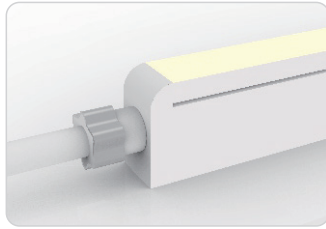

Seamless End Exit

NA-11B-1-01-XW-SE-0-EN-XXX-S

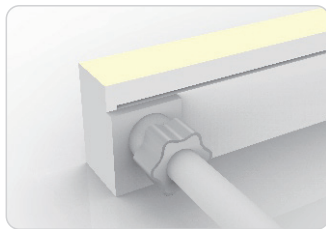
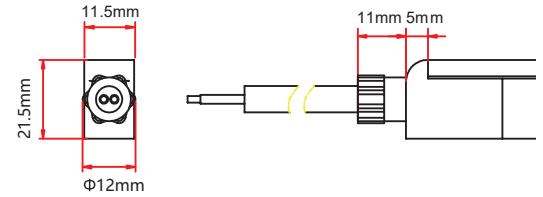

Seamless Side Exit

NA-11B-1-01-XW-SE-1-SR-XXX-S
NA-11B-1-01-XW-SE-2-SL-XXX-S

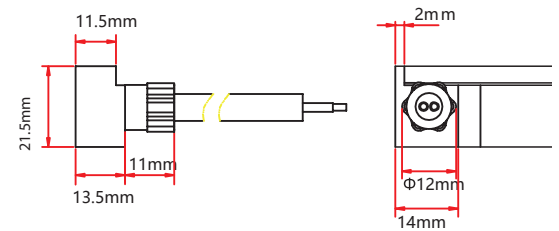

Seamless Bottom Exit

NA-11B-1-01-XW-SE-0-BO-XXX-S

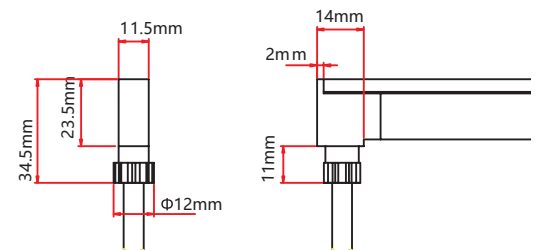

Seamless End Cap

NA-11B-1-01-XW-SE-0-EC

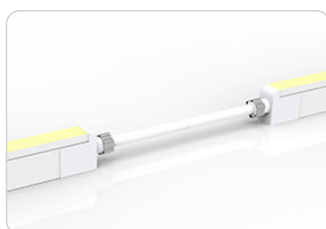
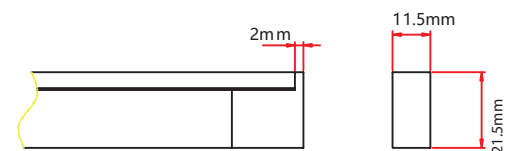

Seamless Jumper

NA-11B-1-01-XW-SE-0-EJ-XXX-S

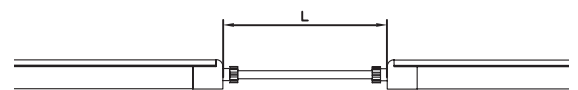

Connectors

IP68: Submersible. Waiting on 3rd party certification from UL as of 18/04/12. Factory Assembly only.

Submersible Seamless Connectors

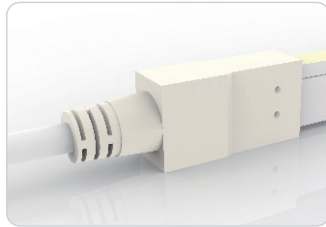

Submersible End Exit
NA-11B-1-01-XW-SU-0-EN-XXX-S

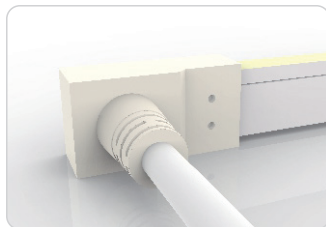
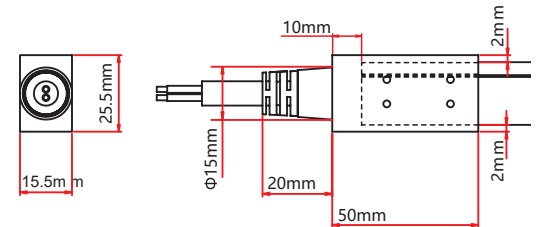

Submersible Side Exit
NA-11B-1-01-XW-SU-1-SR-XXX-S
NA-11B-1-01-XW-SU-2-SL-XXX-S

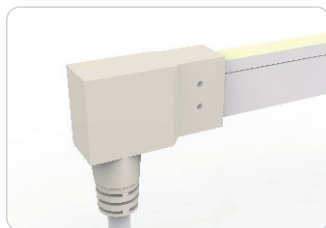
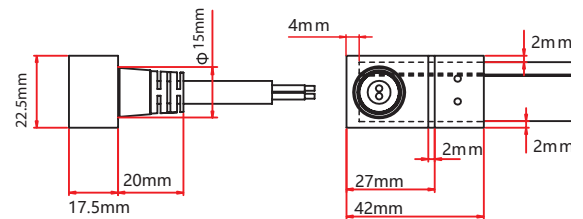

Submersible Bottom Exit
NA-11B-1-01-XW-SU-0-BO-XXX-S

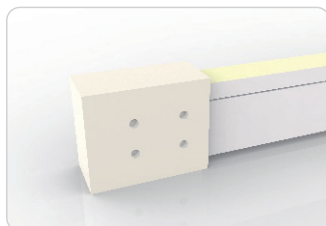
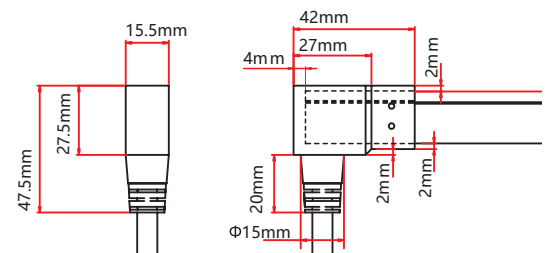

Submersible End Cap
NA-11B-1-01-XW-SU-0-EC

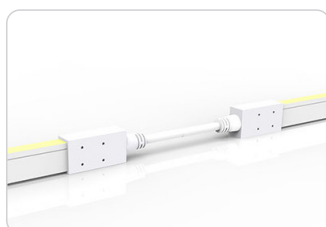
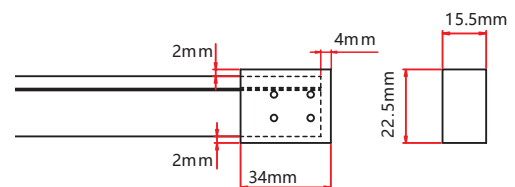

Submersible Jumper
NA-11B-1-01-XW-SU-0-EJ-XXX-S

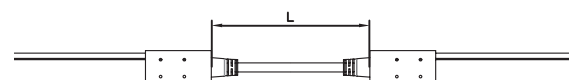

Connectors

Snap Connectors

IP67: Rated for outdoor use.
Factory Assembly or DIY.

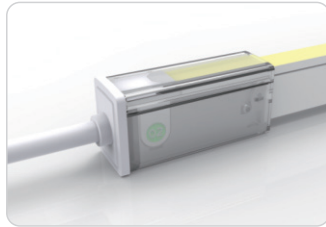

Snap End Exit

NA-11B-1-01-XW-SC-1-EN-XXX-S
NA-11B-1-01-XW-SC-2-EN-XXX-S

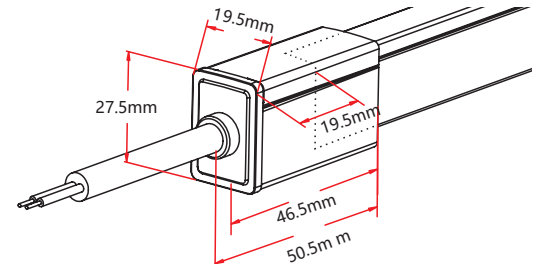

Snap Bottom Exit

NA-11B-1-01-XW-SC-1-BO-XXX-S
NA-11B-1-01-XW-SC-2-BO-XXX-S

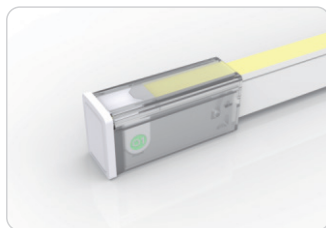
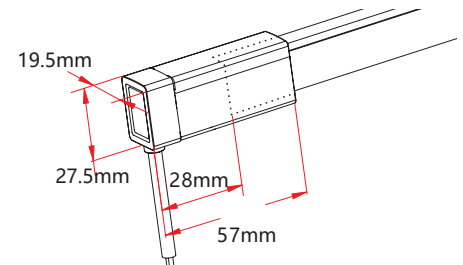

Snap End Cap

NA-11B-1-01-XW-SC-1-EC
NA-11B-1-01-XW-SC-2-EC

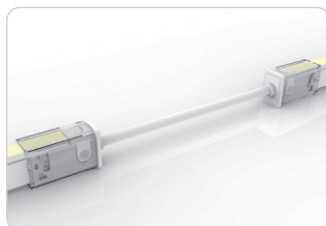
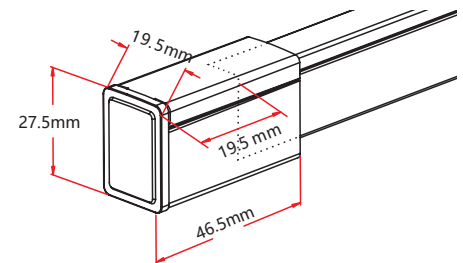

Snap Jumper

NA-11B-1-01-XW-SC-0-EJ-XXX-S

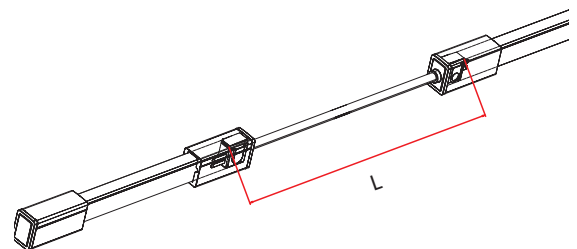

Snap Power T Feed

NA-11B-1-01-XW-SC-0-TF-XXX-S

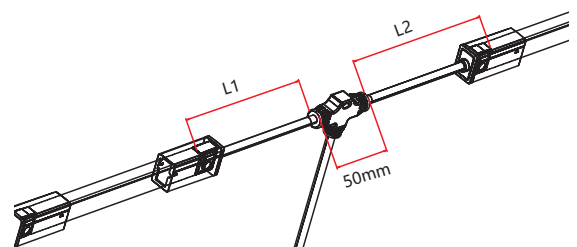

Connectors

IP20: Rated for indoor use only.
Factory Assembly only.

Barrel Connectors



Barrel Connectors

- NA-XX-BC-DC-CXX-F
- NA-XX-BC-DC-CXX-M
- NA-XX-BN-XXA-CXX-F
- NA-XX-BN-XXA-CXX-M
- NA-XX-PL-XXA-CXX-F
- NA-XX-PL-XXA-CXX-M

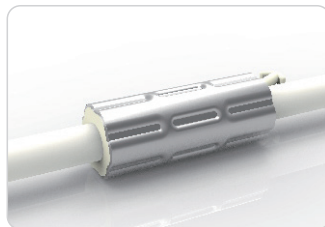
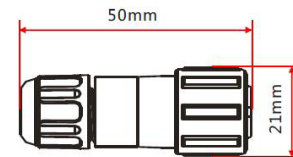

Anti-Wicking Ferrule

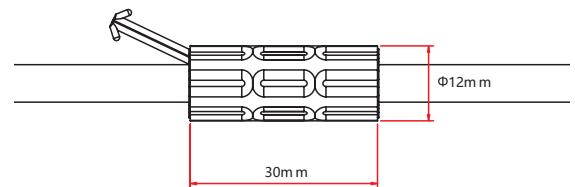

Anvil Cutter

Optional accessory for on-site cutting.

Factory order only

Mounting Hardware

Standard Anodized Aluminum Channel

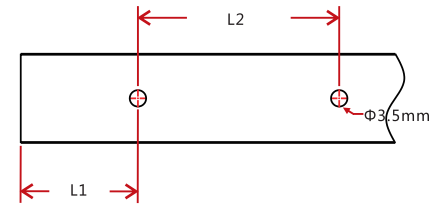
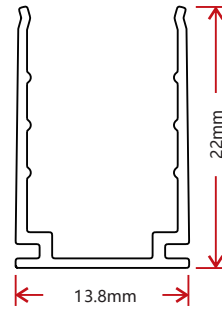
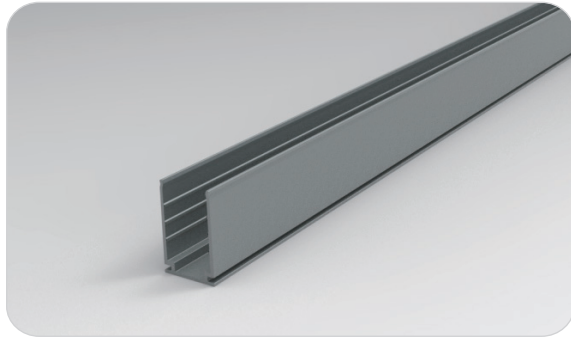

W x H	Standard Length	Part Number	L1	L2	Screw Hole Φ	Hole #
0.54 x 0.87in (13.8 x 22mm)	1.38in (35mm)	CL-11-R-AL-3C5-SD	0.69in (17.5mm)	/	Φ 0.14in (3.5mm)	1
	19.69in (500mm)	CH-11-R-AL-0M5-SD	1.97in (50mm)	7.87in (200mm)	Φ 0.14in (3.5mm)	3
	39.37in (1000mm)	CH-11-R-AL-01M-SD	3.94in (100mm)	7.87in (200mm)	Φ 0.14in (3.5mm)	5
	78.74in (2000mm)	CH-11-R-AL-02M-SD	3.94in (100mm)	7.87in (200mm)	Φ 0.14in (3.5mm)	10

Plastic Channel

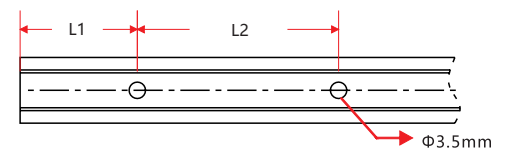
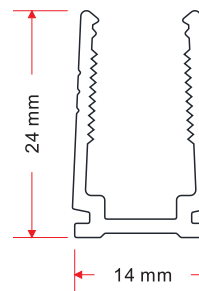

W x H	Standard Length	Part Number	L1	L2	Screw Hole Φ	Hole #
0.55 x 0.94in (14 x 24mm)	19.69in (500mm)	CH-11-R-PL-0M5-SD	1.97in (50mm)	7.87in (200mm)	Φ 0.14in (3.5mm)	3
	39.37in (1000mm)	CH-11-R-PL-01M-SD	3.94in (100mm)	7.87in (200mm)	Φ 0.14in (3.5mm)	5
	78.74in (2000mm)	CH-11-R-PL-02M-SD	3.94in (100mm)	7.87in (200mm)	Φ 0.14in (3.5mm)	10

Mounting Hardware

Spring Clip Anodized Aluminum Channel

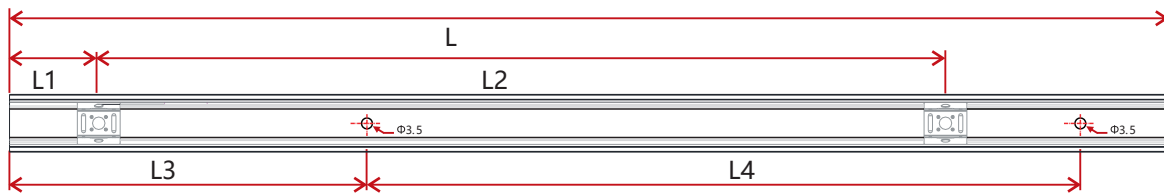
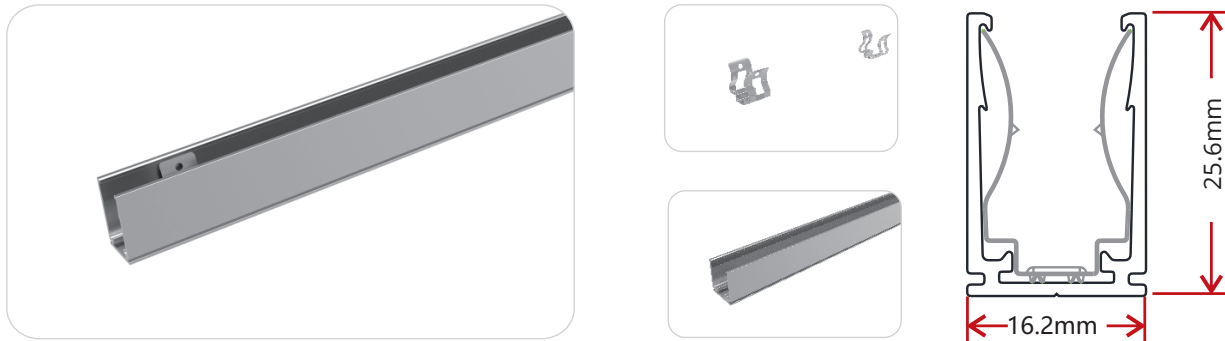

W x H	Standard Length	Part Number	L1	L2	L3	L4	Screw Hole Φ	Hole #	Clip #
0.64 x 1.01in	1.38in (35mm)	CL-11-R-AL-3C5-SP	0.69in (17.5mm)	/	0.2in (5mm)	0.98in (25mm)	Φ 0.14in (3.5mm)	2	1
(16.2 x 25.6mm)	19.69in (500mm)	CH-11-R-AL-0M5-SP	0.98in (25mm)	8.86in (225mm)	1.97in (50mm)	7.87in (200mm)	Φ 0.14in (3.5mm)	3	3
	39.37in (1000mm)	CH-11-R-AL-01M-SP	0.98in (25mm)	9.35in (237.5mm)	3.94in (100mm)	7.87in (200mm)	Φ 0.14in (3.5mm)	5	5
	78.74in (2000mm)	CH-11-R-AL-02M-SP	0.98in (25mm)	9.6in (243.8mm)	3.94in (100mm)	7.87in (200mm)	Φ 0.14in (3.5mm)	10	9

Stainless Steel Flexible Channel

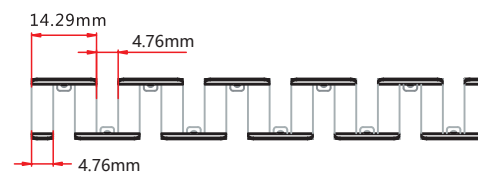
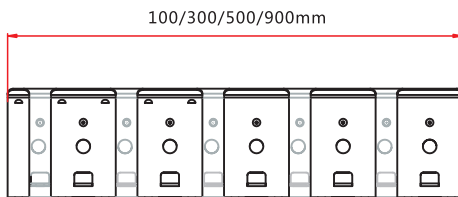
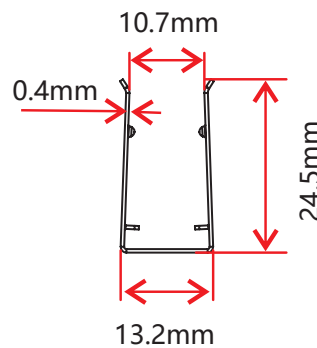

W x H	Standard Length	Part Number
0.52 x 0.97in	3.94in (100mm)	CH-11-F-SS-0M1-SD
(13.2 x 24.5mm)	11.81in (300mm)	CH-11-F-SS-0M3-SD
	19.69in (500mm)	CH-11-F-SS-0M5-SD
	35.43in (900mm)	CH-11-F-SS-0M9-SD

This profile can be mounted using screws in any gaps where the channel bends.

Packaging



White Box

Packing Box

Fixture Length	White Box Dimensions	Packing Box Dimensions	# Of White Boxes	Package Weight
196.85in (5m)	13.78x1.65x18.11in (35x4.2x46cm)	18.9x14.57x9.54in (48x37x24cm)	5	22.05lbs (10kg)
393.7in (10m)	20.08x1.65x22.05in (45x4.2x56cm)	22.83x18.5x9.45in (58x47x24cm)	5	39.68lbs (18kg)
787.4in (20m)	26.77x1.65x28.34in (61x4.2x72cm)	29.13x25x4.13in (74x63.5x10.5cm)	2	33.07lbs (15kg)

Testing

Photometric Data

W+WW

LED Type	SMD	
Beam Angle	160 °	
Color	Wavelength	Lumen/m
W	2460 ± 120K	>110lm
WW	5029 ± 283K	>110lm
W+WW	3465 ± 245K	>220lm

Testing

Certifications

	Testing Organization	Certificate Serial N°	Report Reference
UL 2108	UL	20160726-E360029	E360029-2013
CE-EMC	SGS	SZEM1702001259LMV	SZEM160600421302

Fixture Testing

Optical Testing

Spectrum Analysis	IES LM 79 (Lumen, CCT, CRI, XY, SDCM, wavelength)
Photometric Distribution	IES LM 73 (Lumen intensity distribution & Lux diagram)
Lumen Maintenance & Lifetime	IES LM 84 & IES TM28

Temperature Testing

Normal Temperature Test	UL1598 & UL2388 & IEC60598-1 & IEC60598-2-21
Abnormal Operation Test	UL1598 & UL2388 & IEC60598-1 & IEC60598-2-21

Durability Testing

Bending Test	Manufacturer-defined, 500 cycles
Swing Test	UL2388, >750 cycles
Tensile Test	Manufacturer-defined, > the weight of light in max. connection length double feed
Twist Test	Max connection length double feed Manufacturer-defined, >200 cycles
Ball Impact	UL1598 & UL2388 & IEC60598-1 & IEC60598-2-21
IK07 IK08	IEC62262

Environmental Testing

Chlorinated Water Immersion	BG9667, PH6.8-7.6, free chlorine 0.3-0.6mg/L
Salt Water Immersion	IEC60598-1, Salinity 4%
Salt Spray Test	IEC68-2-11
Outdoor Exposure	Manufacturer-defined
Flame Resistance	UL94
UV Exposure	ASTMG 154, ISO 4892-3, UVA @ 340nm
IPX5, IPX6, IPX7, IPX8	IEC60529
Temperature Shock	Manufacturer-defined, -40°C - 60°C (typical temperature range)
Constant Temperature	Manufacturer-defined

Testing

Charts

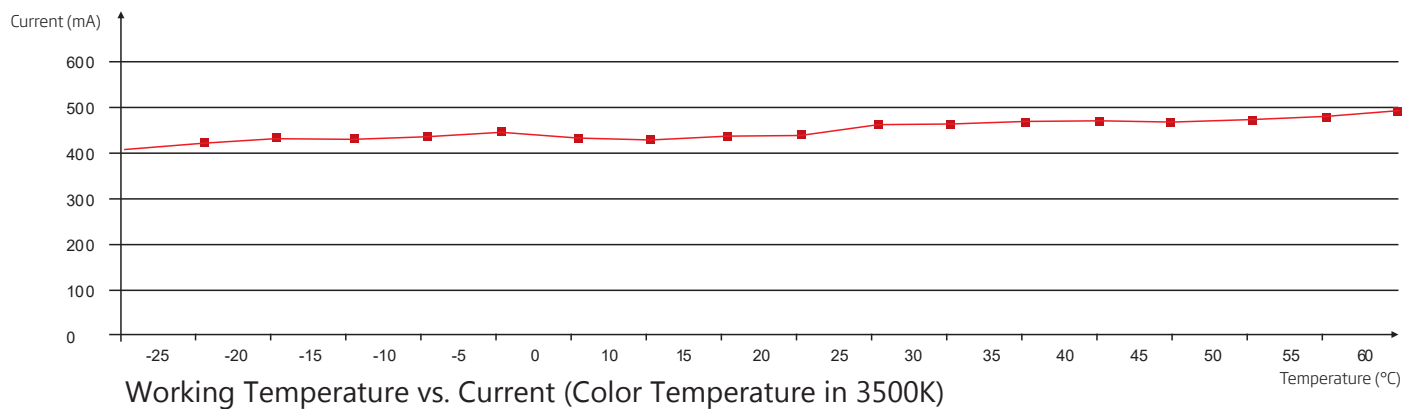
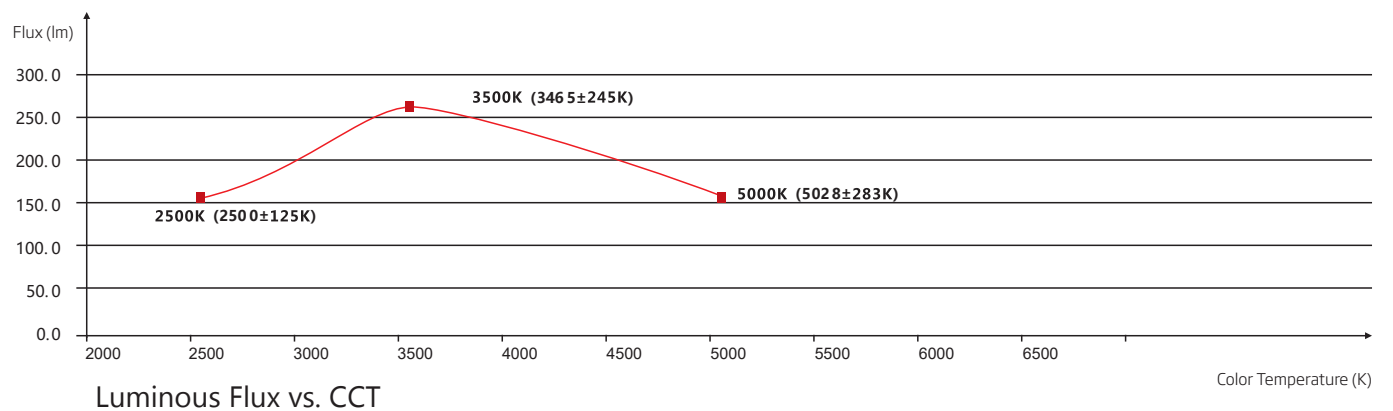
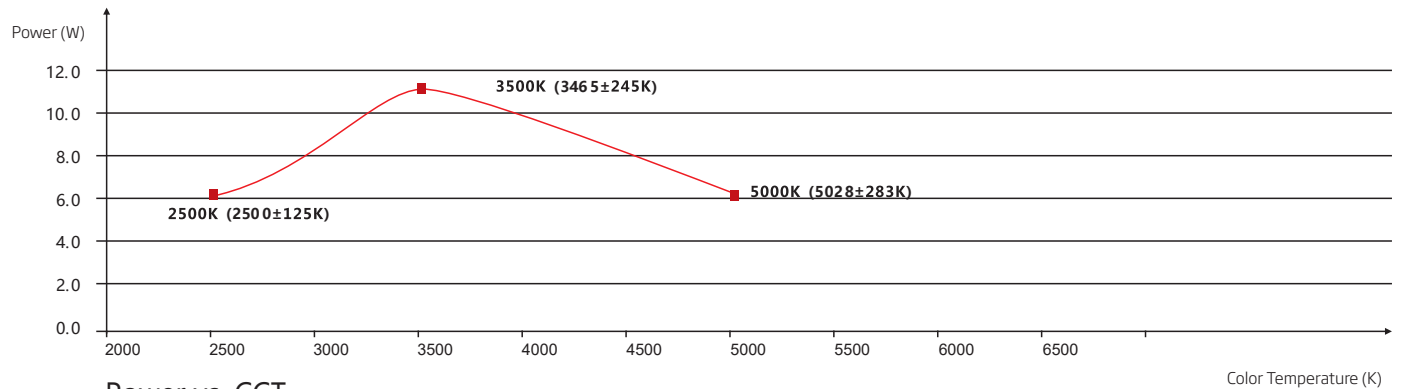

Testing

Charts

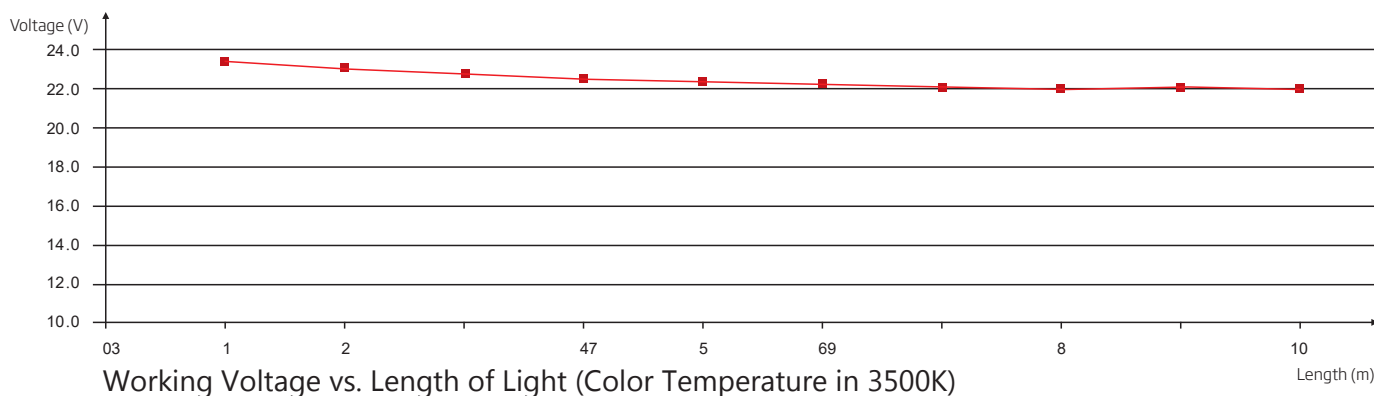

ANSI STANDARD

Nominal CCT Categories

Nominal CCT	Target CCT and tolerance(K)	Target D_{uv}	D_{uv} Tolerance Range
2200K	2238 ±102	0.0000	Tx:CCT of the source
2500K	2460±120	0.0000	For Tx<2870K
2700K	2725 ±145	0.0000	0.000±0.0060
3000K	3045±175	0.0001	For Tx≥2870K
3500K	3465±245	0.0005	$D_{uv}(Tx)±0.0060$
4000K	3985±275	0.0010	where
4500K	4503±243	0.0015	$D_{uv}(Tx)=57700 \times (1/Tx)^2$
5000K	5029±283	0.0020	-44.6 × (1/Tx)
5700K	5667±355	0.0025	+0.00854
6500K	6532±510	0.0031	
Flexible CCT (2200-6500K)	$T_F^{1)} ± \Delta T^{2)}$	$D_{uv} T_F^{3)}$	

Remark:

- 1) T_F is chosen to be at 100K steps (2300,2400,.....,6400K),excluding the ten nominal CCTs listed in Table 1.
- 2) $\Delta T = 1.1900 \times 10^6 \times T^3 - 1.5434 \times 10^4 \times T^2 + 0.7168 \times T - 902.55$
- 3) Same as in the D_{uv} Tolerance Range.



Testing

Charts

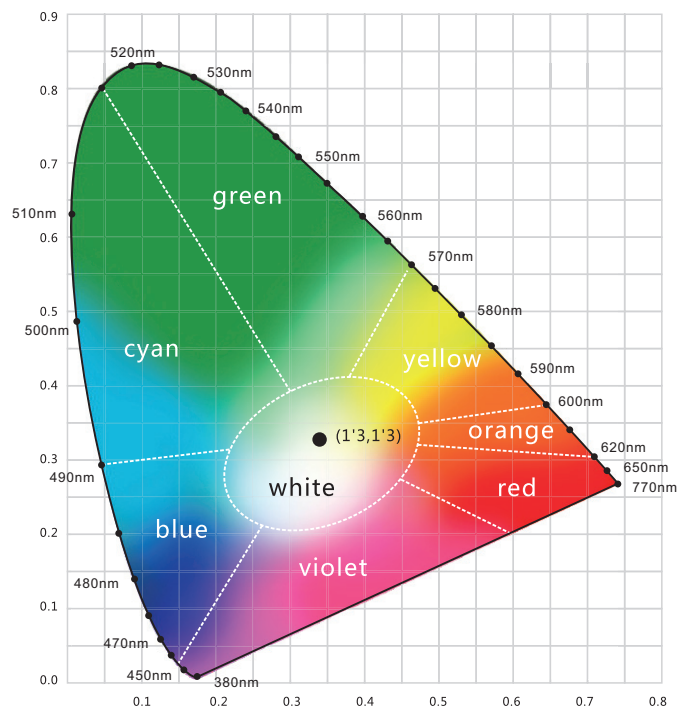
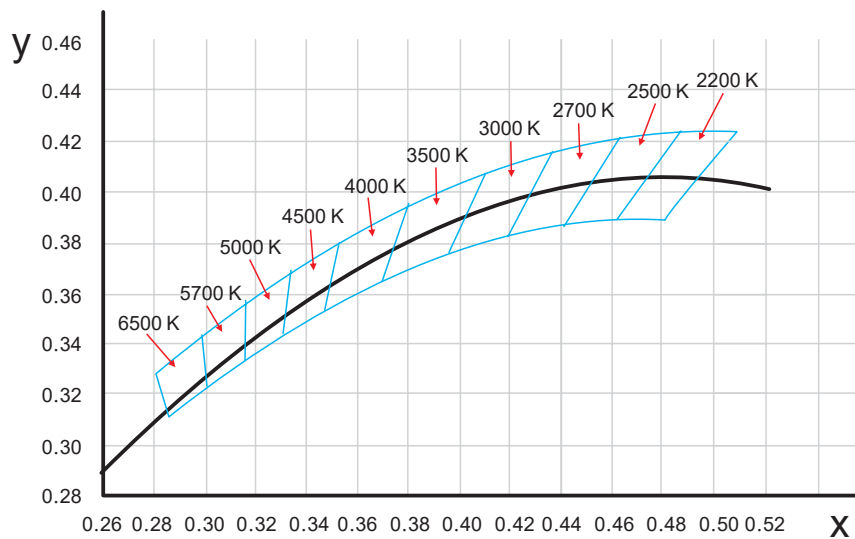
(X,Y) Chromaticity Diagram



Light Color

-  **Red**
620-630nm
-  **Green**
520-530nm
-  **Blue**
465-475nm

Testing

Charts

Loading Chart

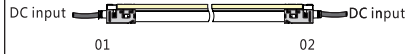
		Power Supply								
Rated Power	35W	60W	75W	80W	100W	120W	150W	185W	240W	320W
3.66W/ft (12W/m)	6.56ft (2m)	11.48ft (3.5m)	14.76ft (4.5m)	16.4ft (5m)	19.69ft (6m)	22.97ft (7m)	32.81ft (10m)	39.37ft (12m)	45.93ft (14m)	65.62ft (20m)
Lead Type	Single Feed						Double Feed			
										
	01/02						01 02			

Note: These are the max recommended run lengths based on power supply

For example: It is recommended to use one 80W power supply for a single-fed run of 16.4ft (5m) at 3.66W/ft (12W/m).